

UNCONTROLLED DOCUMENT

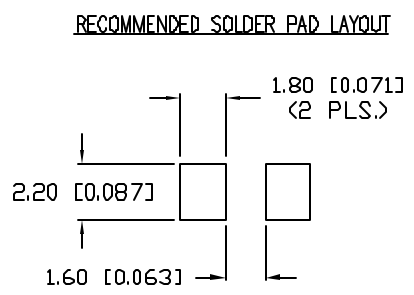
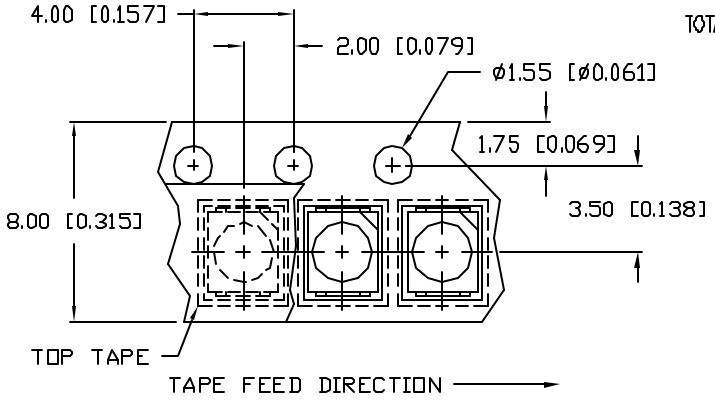
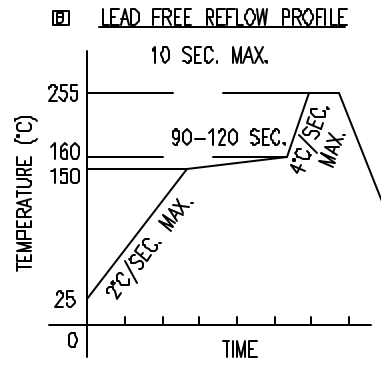
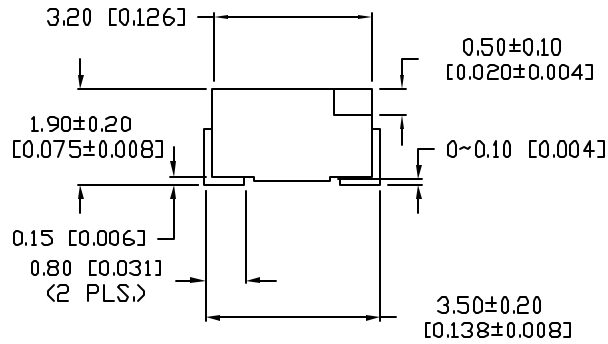
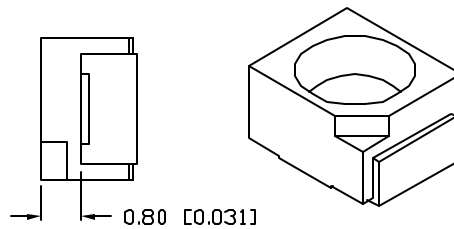
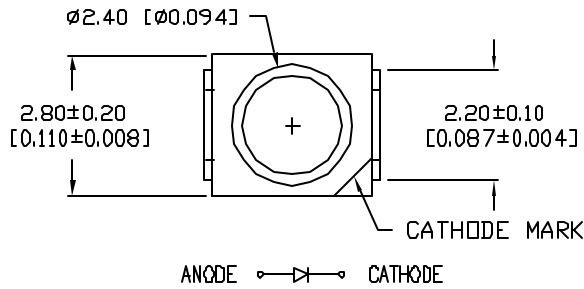

PART NUMBER		REV.
SML-LX2832GC-TR		C
REV.	E.C.N. NUMBER AND REVISION COMMENTS	DATE
A	E.C.N. #10967.	3.14.03
B	E.C.N. #11148.	2.8.05
C	E.C.N. #11402.	03.16.07

ELECTRO-OPTICAL CHARACTERISTICS $T_A=25^{\circ}\text{C}$ $I_f=20\text{mA}$

PARAMETER	MIN	TYP	MAX	UNITS	TEST COND
PEAK WAVELENGTH		565		nm	
FORWARD VOLTAGE		2.1	2.8	V_f	
REVERSE VOLTAGE	5.0			V_r	$I_f=100\mu\text{A}$
AXIAL INTENSITY	10	25		mcd	$I_f=20\text{mA}$
VIEWING ANGLE		120		2x theta	
EMITTED COLOR:	GREEN				
EPOXY LENS FINISH:	WATER CLEAR				

LIMITS OF SAFE OPERATION AT 25°C

PARAMETER	MAX	UNITS
PEAK FORWARD CURRENT*	160	mA
STEADY CURRENT	25	mA
POWER DISSIPATION	100	mW
DERATE FROM 25°C	-1.2	mW/°C
OPERATING TEMP.	-40 TO +85	°C
STORAGE TEMP.	-40 TO +85	°C

* $t < 10\mu\text{s}$

NOTES:

- THE POLARITY MARK IS ORIENTED TOWARDS THE TAPE SPROCKET HOLE.

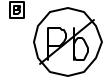

CAUTION: MOISTURE SENSITIVE DEVICE
PER JEDEC LEVEL 4 STANDARDS

UNCONTROLLED DOCUMENT

*UNLESS OTHERWISE SPECIFIED TOLERANCES PER DECIMAL PRECISION ARE: X=±1 (±0.039), XX=±0.5 (±0.020), XXX=±0.25 (±0.010), XXXX=±0.127 (±0.005). LEAD SIZE=±0.05 (±0.002), LEAD LENGTH=±0.75 (±0.030), MIN=+DECIMAL PRECISION MAX.=+0.00 -DECIMAL PRECISION

REV.	PART NUMBER
C	SML-LX2832GC-TR

CONFIDENTIAL INFORMATION
THE INFORMATION CONTAINED IN THIS DOCUMENT IS THE PROPERTY OF LUMEX INC. EXCEPT AS SPECIFICALLY AUTHORIZED IN WRITING BY LUMEX INC, THE HOLDER OF THIS DOCUMENT SHALL KEEP ALL INFORMATION CONTAINED HEREIN CONFIDENTIAL AND SHALL PROTECT SAME IN WHOLE OR IN PART FROM DISCLOSURE AND DISSEMINATION TO ALL THIRD PARTIES.



290 E. HELEN ROAD
PALATINE, IL 60067-6976
PHONE: +1.847.359.2790
US WEB: www.lumex.com
TW WEB: www.lumex.com.tw

2.8mm x 3.2mm SURFACE MOUNT LED WITH REFLECTOR,
565nm GREEN LED, WATER CLEAR LENS,
2,000 PIECES PER TAPE AND REEL.

RELIABILITY NOTE
OUR MANY YEARS OF EXPERIENCE DATA ACCUMULATION INDICATE THAT SOLDER HEAT IS A MAJOR CAUSE OF EARLY AND FUTURE FAILURE. PLEASE PAY ATTENTION TO YOUR SOLDERING PROCESS.

DRAWN BY:	CHECKED BY:	APPROVED BY:	DATE:
JC			1.11.01
			PAGE: 1 OF 1
			SCALE: N/A